

Features:

- Two-way passive speaker with one 10" woofer and one 1.5" driver.
- Cabinet is made from polypropylene and special high-tech material in large injection mold. It's durable, anti-shock and has good damping characters.
- Voice coil in the 10" woofer is made from \varnothing 75mm copper cladding aluminium ribbon wire.
- Heavy duty protective grille.
- The high frequency driver is protected by special design circuit to avoid being damaged when overload.
- Rotatable 90° x 60° (HxV) dispersion horn makes it suitable for any performance purposes.
- Molded-in pole mount, easily suspended.
- Arrayable vertically in 4 layers or horizontally in more than 8 columns.

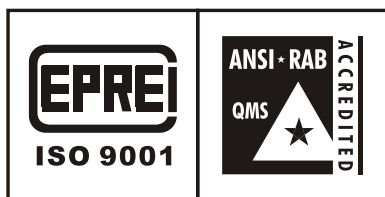

Beta Three



Model: UIO

Technical Parameters

System:	Built-in Crossover Two Way Full Range Speaker	
Driver Quantity:	10" x1(Bass)	1x \varnothing 34mm Driver
Frequency Response(-3dB):	65Hz-18KHz	
Frequency Response(-10dB):	55Hz-20KHz	
Sensitivity(dB/1M/1W):	95 dB	
Impedance:	8 Ohm	
Recommendatory Power(RMS/W):	250 W	
Max Sound Level(dB/1M):	119dB	
Tweeter Dispersion(HxV):	90°x60°	
Harmonic Distortion:	≤ 1%	
Connectors:	2xNL4	
Dimensions(WxDxH mm/pcs):	321X321X464mm	
Packing Dimensions(WxDxH mm/pcs)	375X355X535mm	
Net Weight(Kg/pcs):	10Kg	
Gross Weight(Kg/pcs):	12.0Kg	

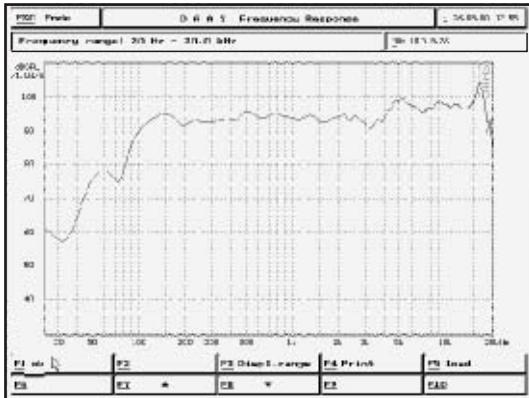

Frequency response, SPL/2.83v

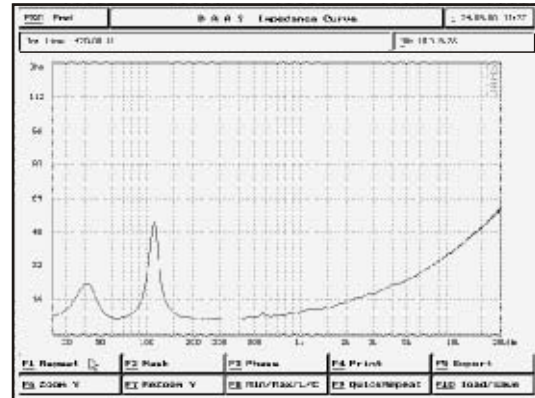

Impedance curve

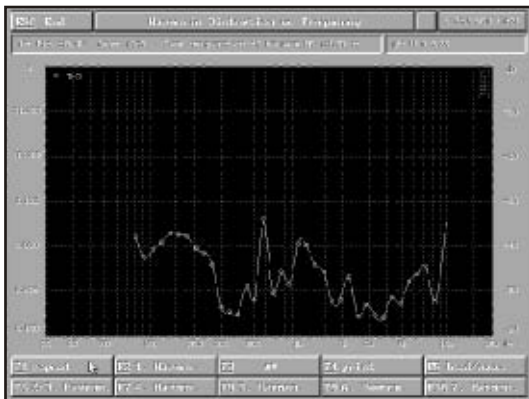

Harmonic distortion 106dB/2.5m, nominal impedance

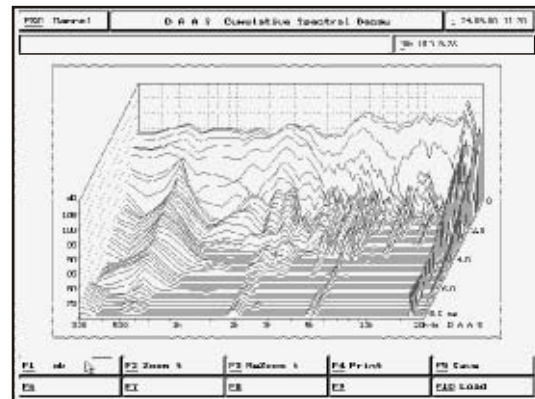

Waterfall spectrum analysis

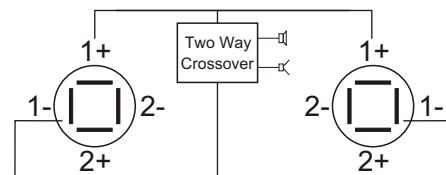
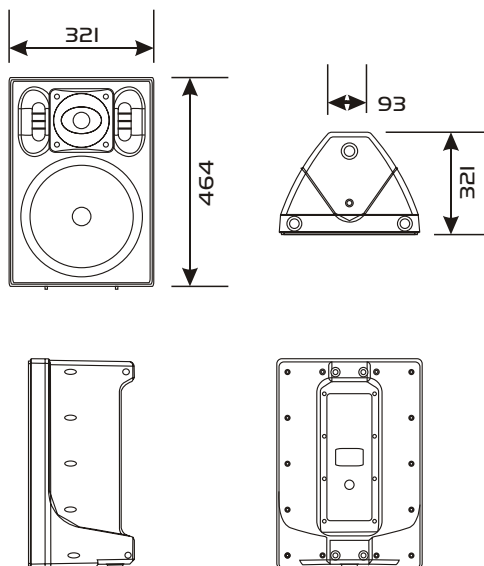

Two Way Crossover

Cosmetic changes may be made